



Product Fiche

Supplier Name or Brand	Arada Ltd
Product Code	EB9HE-G5
Energy Efficiency Class	A
Direct Heat Output	3 kW
Indirect Heat Output	9 kW
Energy Efficiency Index	91.5
The useful energy efficiency at nominal heat output and at minimum load	75.2 %

Specific precautions that shall be taken when the local space heater is assembled, installed or maintained: *Product should be installed in accordance with local building regulations. Appliance will become very hot during use.*

Features

Flexifuel	No
Stove body type	Freestanding
Suitable for Smoke Control Areas	No
Suitable for direct air connection	Yes
Suitable for non-combustible 12mm hearth	No
Max operating pressure	3 bar
Max hearth Temperature	105.4 °C
Weight gross (packed kg)	112 Kg

Dimensions

Width	466 mm
Height	570 mm
Depth	417 mm
Flue Diameter	102 mm
Height to centre of rear flue	431 mm
Depth from back to centre of top flue	144 mm
Ideal log length	280 mm

Performance - Wood & Solid Fuel

	Wood Fuel	Smokeless Solid Fuel
Energy Efficiency Class	A	A
Nett Efficiency	75.2 %	75.2 %
Nominal Output to Space	3.0 kW	3.0 kW
Nominal Output to Water	9 kW	9 kW
DIN+ particulate	Nmg/m3	Nmg/m3
Mean Co Emission(@13% O2)	0.49 %	0.49 %
Mean Co2 Emission(@13% O2)	%	%
Mean NOx Emission(@13% O2)	Nmg/m3	Nmg/m3
Mean OGC Emission(@13% O2)	Nmg/m3	Nmg/m3
Flue Gas Mass Flow	6.9 g/s	6.9 g/s
Flue Gas Temperature	342 °C	342 °C

Minimum Distance To Combustibles

To Rear	To Side	Above
140 mm	306 mm	306 mm

Boiler Tapping Measurements

Freestanding Boiler Tapping Measurements.
Rear view example shown. Not to scale.

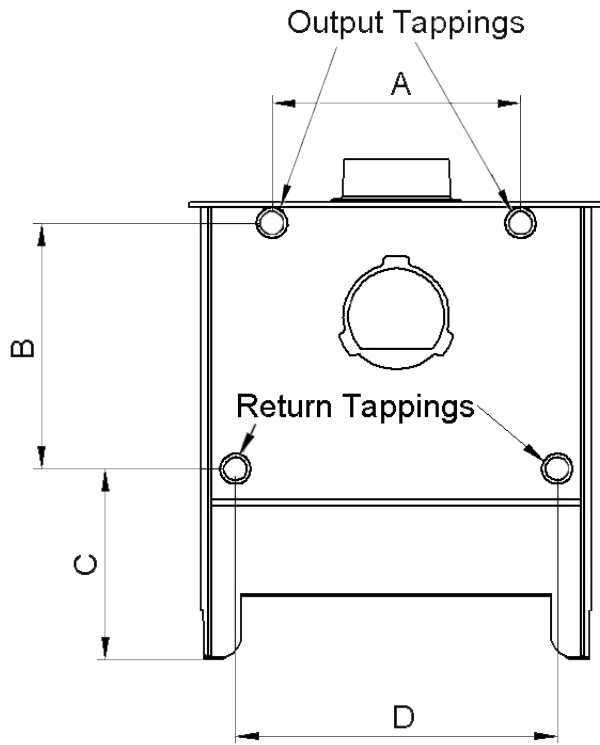

A	B	C	D
260 mm	288 mm	255 mm	356 mm